

Fluorescent Double Lamp Strip Lights



UL FILE NO. E77435
 UL FILE NO. E161465
 CSA FILE NO. LR32783

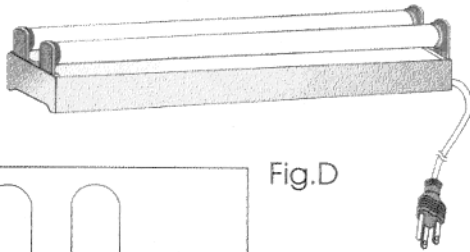

Fig. D

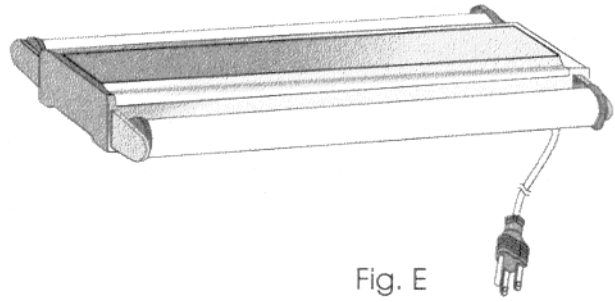
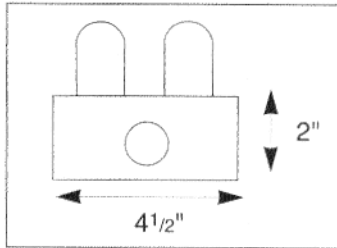
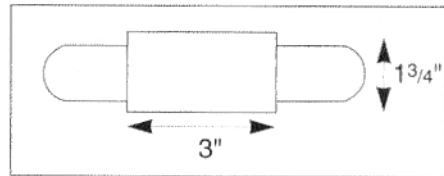

Fig. E



Fluorescent Strip Lights

- For use in display cases, work stations, furniture for dormitories and libraries, etc.
- Standard finish is white.
- Standard power cord is 10', brown, 105°C, 18/3, 10 AMP. Optional white power cords are available.
- Can be supplied without power cord for hardwiring by an electrician.
- Can be supplied with female extensions or wired together in sets up to a maximum of six fixtures. (Contact factory regarding type of wire, plugs, etc.)
- Mount through screw holes in back of fixture after removing cover.

CATALOG NUMBER	BALLAST	LENGTH	LAMP	FIGURE
NC1415-RS	RAPID START	15"	(2)F14T12	D
NC1418-RS	RAPID START	18"	(2)F15T12	D
NC2024-RS	RAPID START	24"	(2)F20T12	D
NC3036-RS	RAPID START	36"	(2)F30T12	D
NC4048-RS+	RAPID START	48"	(2)F40T12	D
NC7272-RS+	RAPID START	72"	(2)F72T12	D
NC9696-RS+	RAPID START	96"	(2)F96T12	D
MI2815-RS	RAPID START	15"	(2)F14T12	E
MI3018-RS	RAPID START	18"	(2)F15T12	E
MI4024-RS	RAPID START	24"	(2)F20T12	E
MI6036-RS	RAPID START	36"	(2)F30T12	E
MI8048-RS+	RAPID START	48"	(2)F40T12	E

+ WITH ENERGY EFFICIENT BALLAST

Fluorescent Single Lamp Strip Lights



UL FILE NO. E77435
 UL FILE NO. E161465
 CSA FILE NO. LR32783

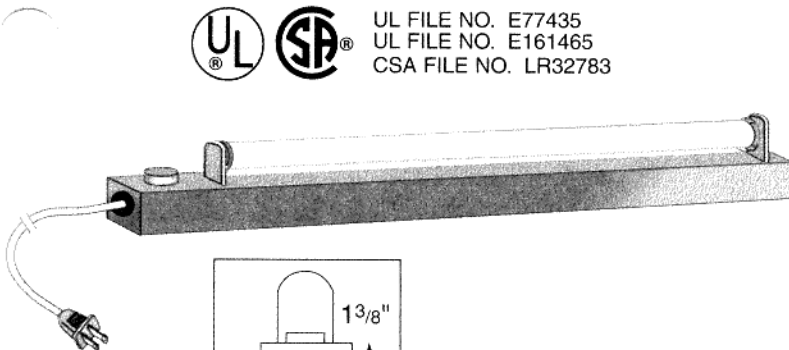

Fig. A

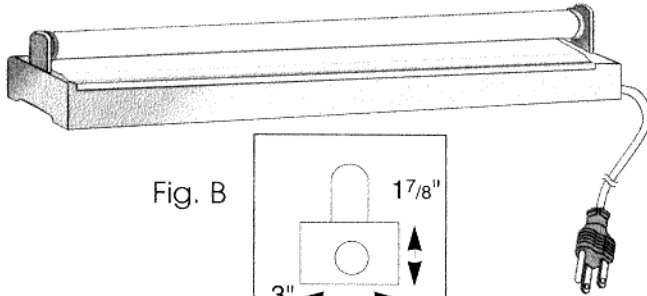
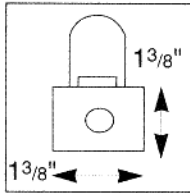

Fig. B

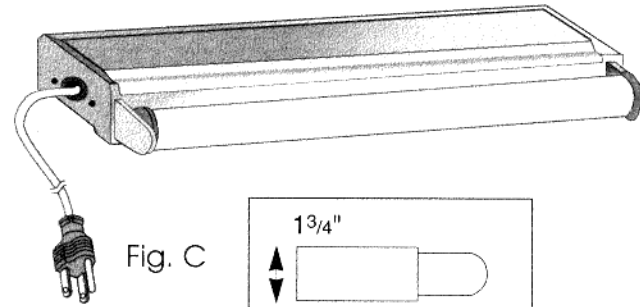
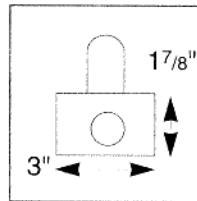
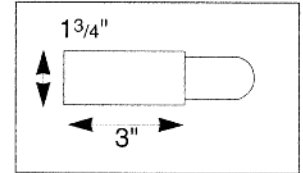

Fig. C



CATALOG NUMBER	BALLAST	LENGTH	LAMP	FIGURE
LP14	PREHEAT	15"	F14T12	B
LP14-RS	RAPID START	15"	F14T12	B
NW15	PREHEAT	18"	F15T12	B
NW-RS	RAPID START	18"	F15T12	B
LW20	PREHEAT	24"	F20T12	B
LW-RS	RAPID START	24"	F20T12	B
RP30-RS	RAPID START	36"	F30T12	B
WW40-RS+	RAPID START	48"	F40T12	B
MI1518-RS	RAPID START	18"	F15T12	C
MI2024-RS	RAPID START	24"	F20T12	C
MI3036-RS	RAPID START	36"	F30T12	C
MI4048-RS+	RAPID START	48"	F40T12	C

† WITH ENERGY EFFICIENT BALLAST



SPECIALITY LIGHTING
 A JJI LIGHTING GROUP COMPANY

639 WASHBURN SWITCH RD. PO BOX 1680, SHELBY, NC 28151-1680
 704-482-3416 • FAX: 704-484-0818

Fluorescent Single Lamp Strip Lights



UL FILE NO. E77435
 UL FILE NO. E161465
 CSA FILE NO. LR32783

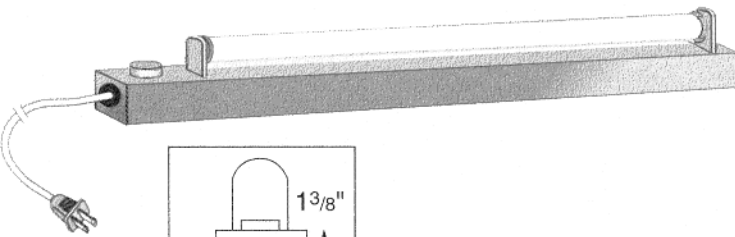

Fig. A

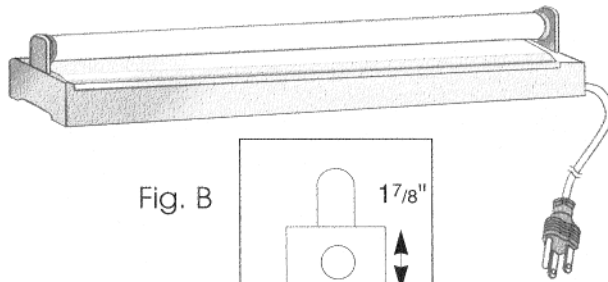
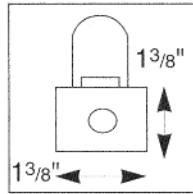

Fig. B

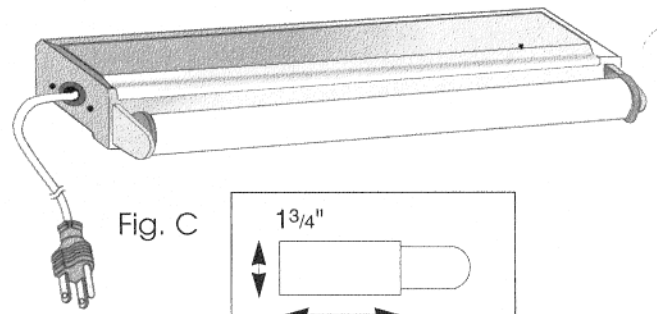
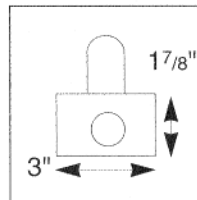
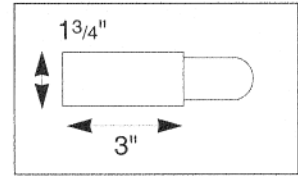

Fig. C



Fluorescent Strip Lights

- For use in display cases, curio cabinets, furniture for dormitories and libraries, etc.
- Standard finish is white.
- Standard power cord is 10', brown, 105°C, 18 AWG, 10 AMP with two or three conductors. Optional white power cords are available. Fixtures with rapid start ballast require 18/3 grounded power cord.
- Can be supplied without power cord for hardwiring by an electrician.
- Can be supplied with female extensions or wired together in sets up to a maximum of six fixtures. (Contact factory regarding type of wire, plugs, etc.)
- Optional push switch or rotary switch available on all units.
- Fixtures with 2-conductor cords can be equipped with in-line rollswitch.
- Mount through screw holes either at end tabs of fixture or in back after removing cover.

CATALOG NUMBER	BALLAST	LENGTH	LAMP	FIGURE
FSO8-S	PREHEAT	13-1/4"	F8T5	A
FSO8	PREHEAT	16"	F8T5	A
FT15	PREHEAT	22"	F15T8	A
FU15	PREHEAT	28"	F15T8-24	A
FU20	PREHEAT	28"	F20T12	A
FE30	PREHEAT	42"	(2)F15T8	A
FF30	PREHEAT	53-1/2"	(2)F15T8-24	A